



ADDICTIVE



JOLLIFICATION

TANGRAM FURY.com

Daily Tangram

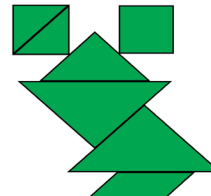
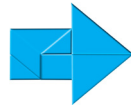
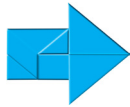
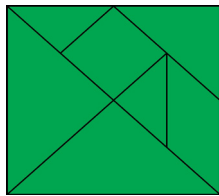

Scan Me for Hints & More Tangram Fun!

Rules:

- All 7 tans must be used, without repeating.
- No tans may overlap.
- Tans may be rotated or flipped.

Today's Tangram

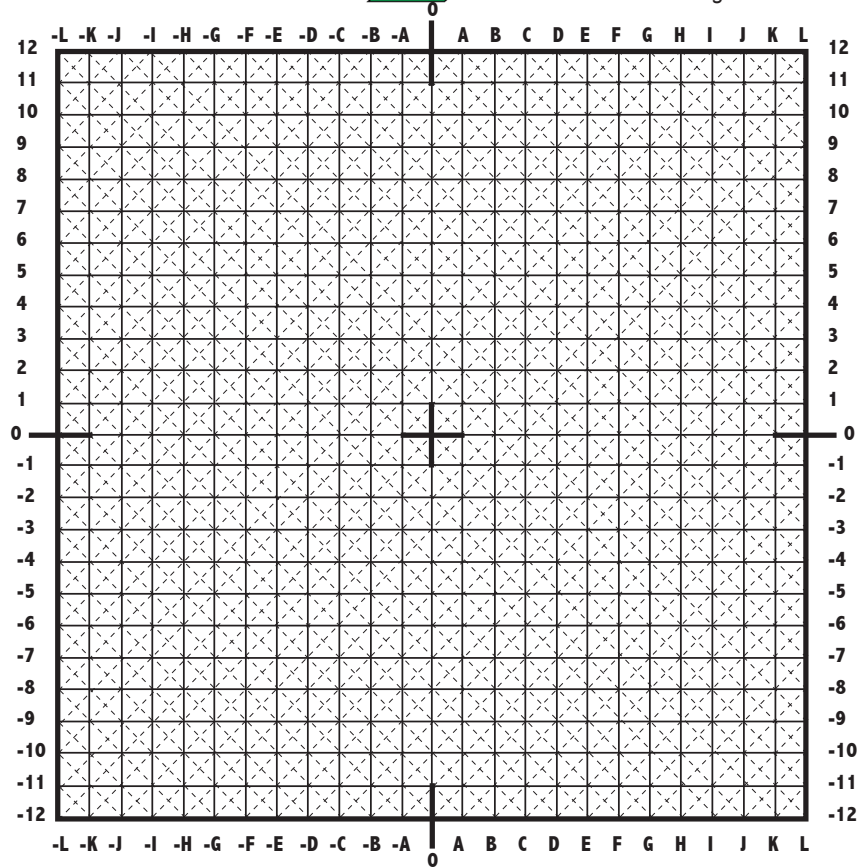
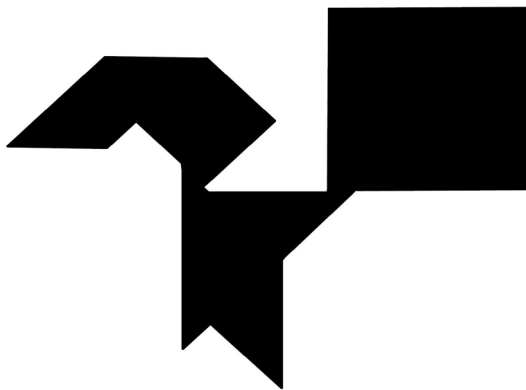

Elf with Christmas Present

Yesterday's Solution

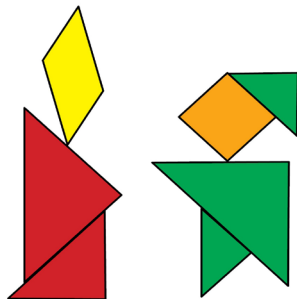

Tans & Sizes

These are the 7 tans to be used and their sizes, based on the Tangram Grid.

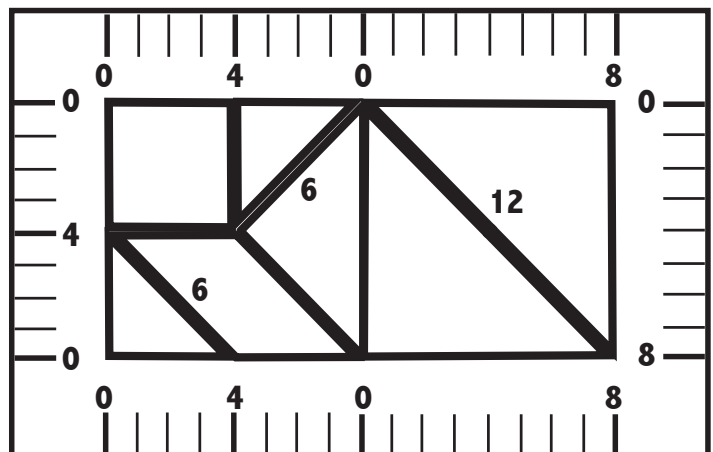

For more tangram fun, including color tangrams, visit www.TangramFury.com