

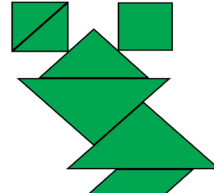

# TANGRAM FURY.com

## Daily Tangram

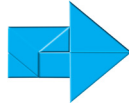
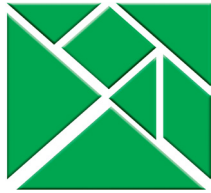
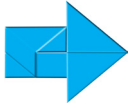
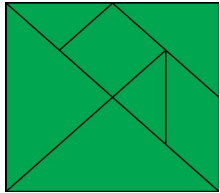

Scan Me for Hints & More Tangram Fun!

### Rules:

- All 7 tans must be used, without repeating.
- No tans may overlap.
- Tans may be rotated or flipped.

### Today's Tangram

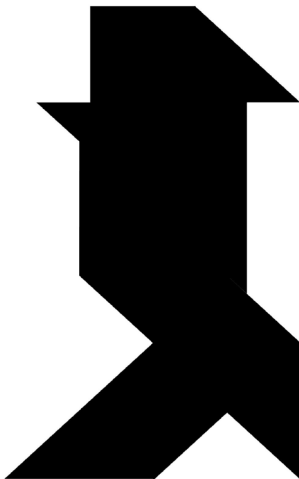

**Tribute to Rose**

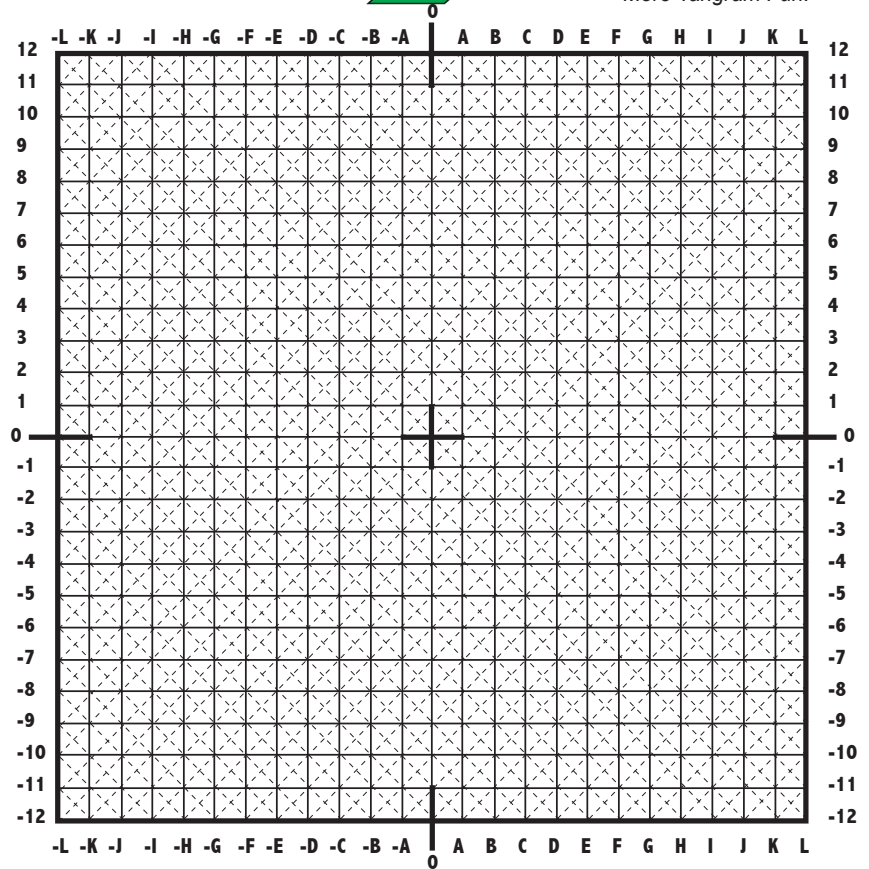

### Tans & Sizes

These are the 7 tans to be used and their sizes, based on the Tangram Grid.

### Yesterday's Solution



**Pocahontas**

These original Comic Con-themed Daily Tangrams are made in honor of celebrities coming to Salt Lake FanX 2019. The collection will be made available in the souvenir book, 'The Tangram Fury Tribute to FanX 2019,' available on Amazon and TangramFury.com.

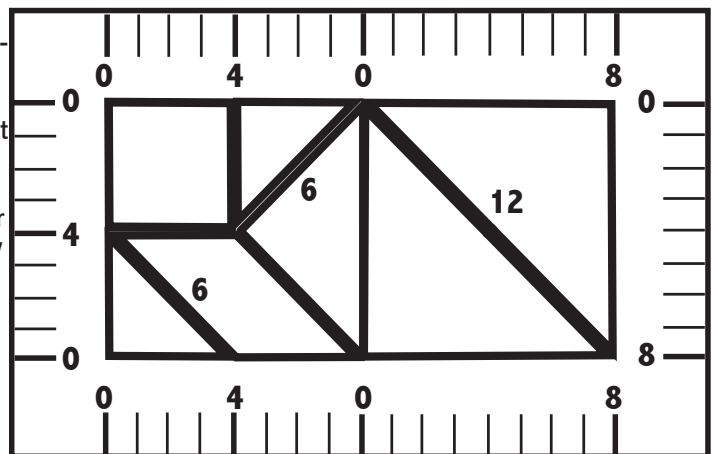

@TangramFury